

Oceanus ROV System – Accessories

Single Axis Manipulator Arm

Designed,
engineered &
manufactured
on-site. | MN

A00034_Oceanus ROV_Manipulator_Arm_&_Acc_V5

Designed to accept a variety of attachments, MarineNav's ROV Manipulator Arm is an essential tool increasing functionality to your ROV, providing power and precision to perform gripping and recovery maneuvers to a depth of up to 300 meters.

A versatile tool built for the most demanding applications



Mechanical Specifications

Grip Force (at tip)	100N*
Grip Force (in middle)	125N*
Jaw Opening 1	72 mm*
Jaw Opening 2	92 mm*
Time to Open/Close	4.5 secs*

Electrical Specifications

Supply Voltage (V_{in})	7 - 22 volts*
Peak Current	3 amps*

Dimensions

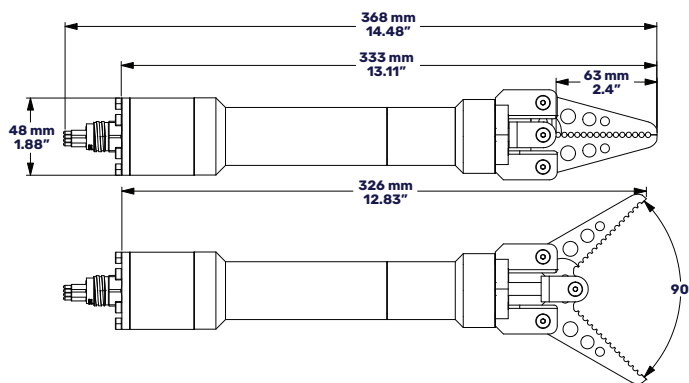

*Specifications, options, and availability subject to change with out notice. Errors and omissions excepted. We reserve the right to limit quantities. Rev January 18, 2021.



Part #: ROV-ACC-ARM



© 2020 MarineNav Ltd.

Panmure Island Rd
Panmure Island, PE COA 1R0
902 838-7011
www.marinenav.ca

Oceanus ROV System – Accessories

Single Axis Manipulator Arm Attachments

Designed,
engineered &
manufactured
on-site. | MN

A00034_Oceanus ROV_Manipulator_Arm_&_Acc_V5

Sediment / Soil Sampler



The Sediment Sampler is equipped with a two-piece shovel mechanism allowing users to safely return samples to the surface. Capacity 240 cubic centimeters or 14.6 cubic inches
Part#:ROV-ACC-SSS

Parallel Jaws



The Parallel Jaws horizontally open and close. They are useful for a wide variety of tasks such as firmly holding, grabbing, lifting, pulling or manipulating an object. Part#:ROV-ACC-PJ

Fish Scoop



The Fish Scoop is equipped with a jaw which opens and closes to firmly scoop and grab fish, aquatic plants and other debris. For more detailed information on the Fish Scoop refer to the Fish Scoop accessory page. Part#:ROV-ACC-GRAB

Custom Builds

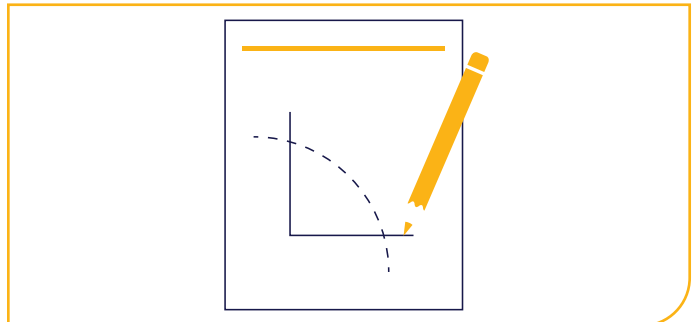

Our in-house team of designers and engineers can build custom manipulator arm attachments tailored to a customer's specific requirements. Please contact our sales team to learn more.